

LM20

Serbatoio rettangolare in acciaio capacità 20 litri
20 liters capacity rectangular steel tank

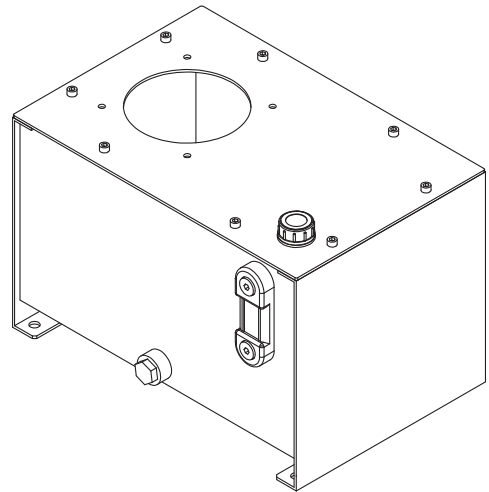
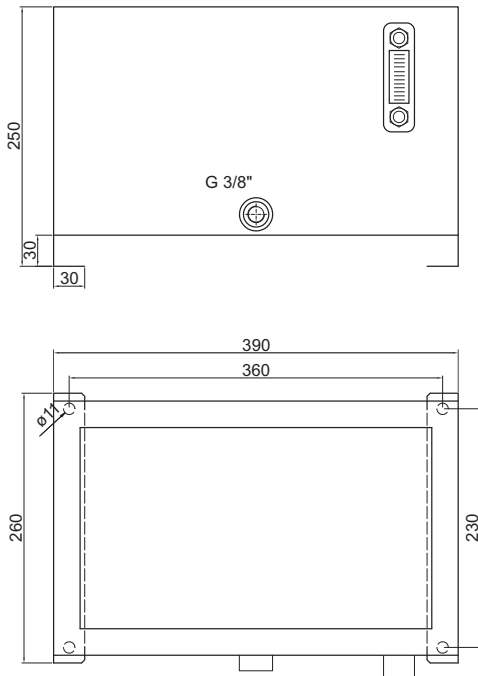

LM30

Serbatoio rettangolare in acciaio capacità 30 litri
30 liters capacity rectangular steel tank

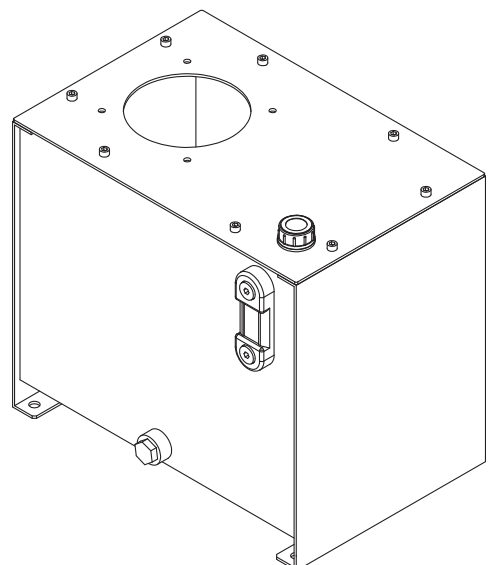
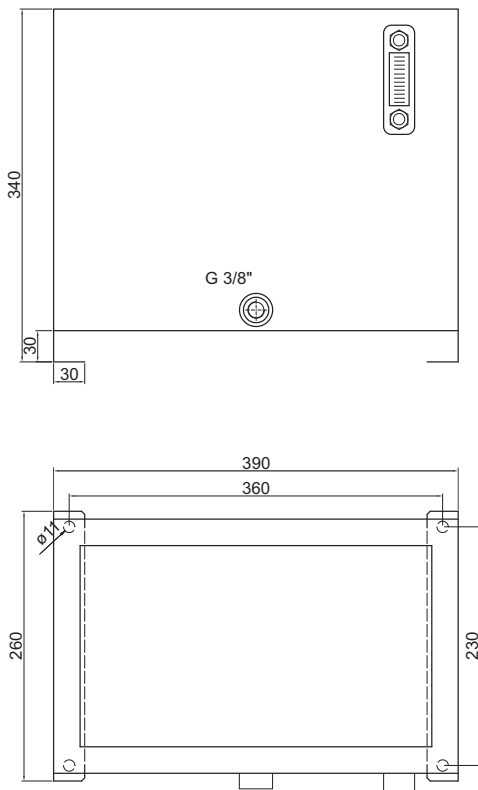

Orientamento Serbatoi - tanks positioning

68

Serie LM

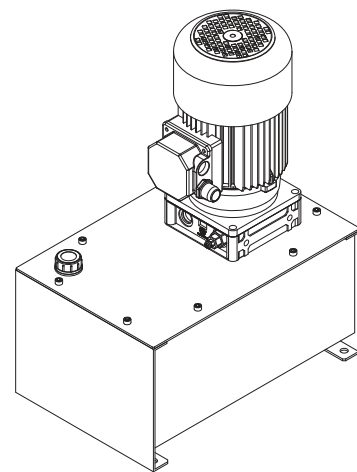
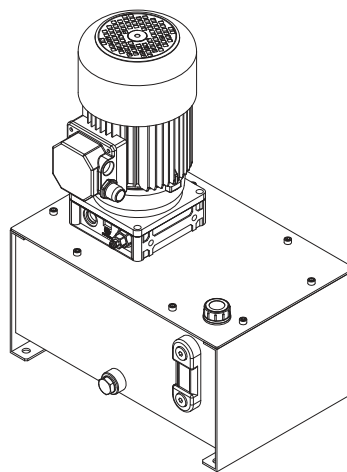
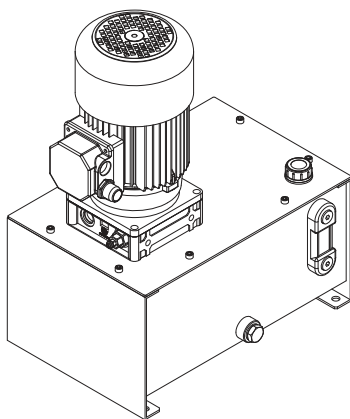
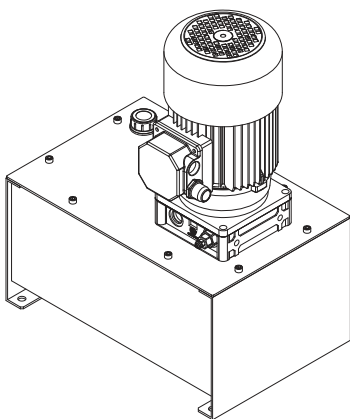
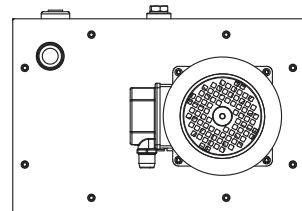
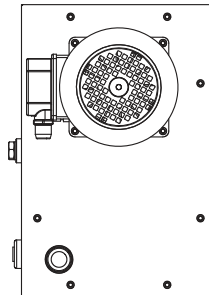
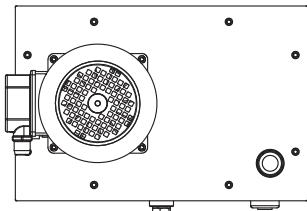
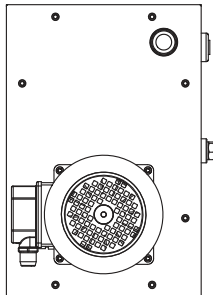
**1** Sinistra - left (std)

tappo di carico verso blocchi modulari
filler cap toward modular blocks

2 Anteriore - front

tappo di carico opposto alla valvola di massima
filler cap on opposite side of the relief valve

3 Destra - right

tappo di carico opposto a blocchi modulari
filler cap on opposite side of the modular blocks

4 Posteriore - rear

tappo di carico verso valvola di massima
filler cap toward relief valve

