

BL010

Blocco modulare con porte laterali 3/8" BSP
Modular manifold with lateral 3/8" BSP ports

Simbolo
symbol

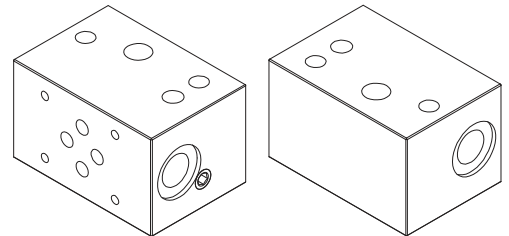
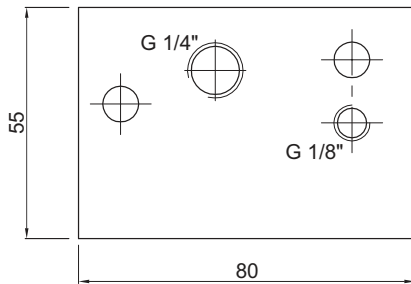
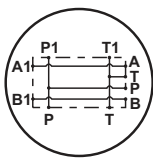
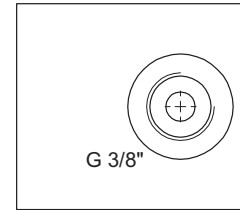
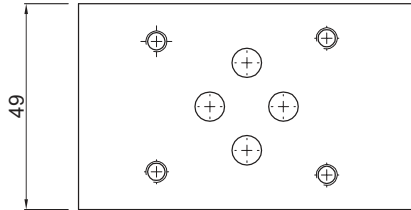

BL011-X-Y

Blocco per circuito semplice effetto aggiuntivo
Manifold for additional single acting circuit

Simbolo
symbol

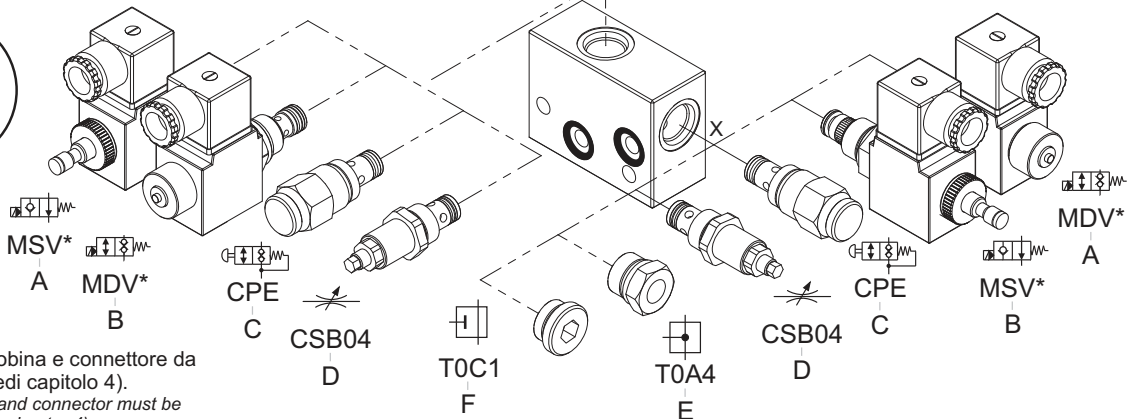
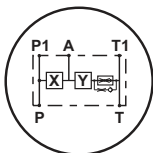
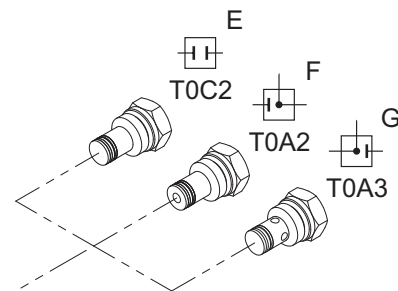
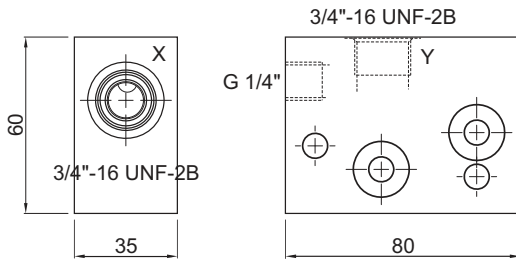

*NB: Tipo, tensione bobina e connettore da specificare a parte (vedi capitolo 4).
*Note: type, coil voltage and connector must be specified separately (see chapter 4).